

**ERGOLINE
INSPIRATION
600**

**DYNAMIC
PERFORMANCE**

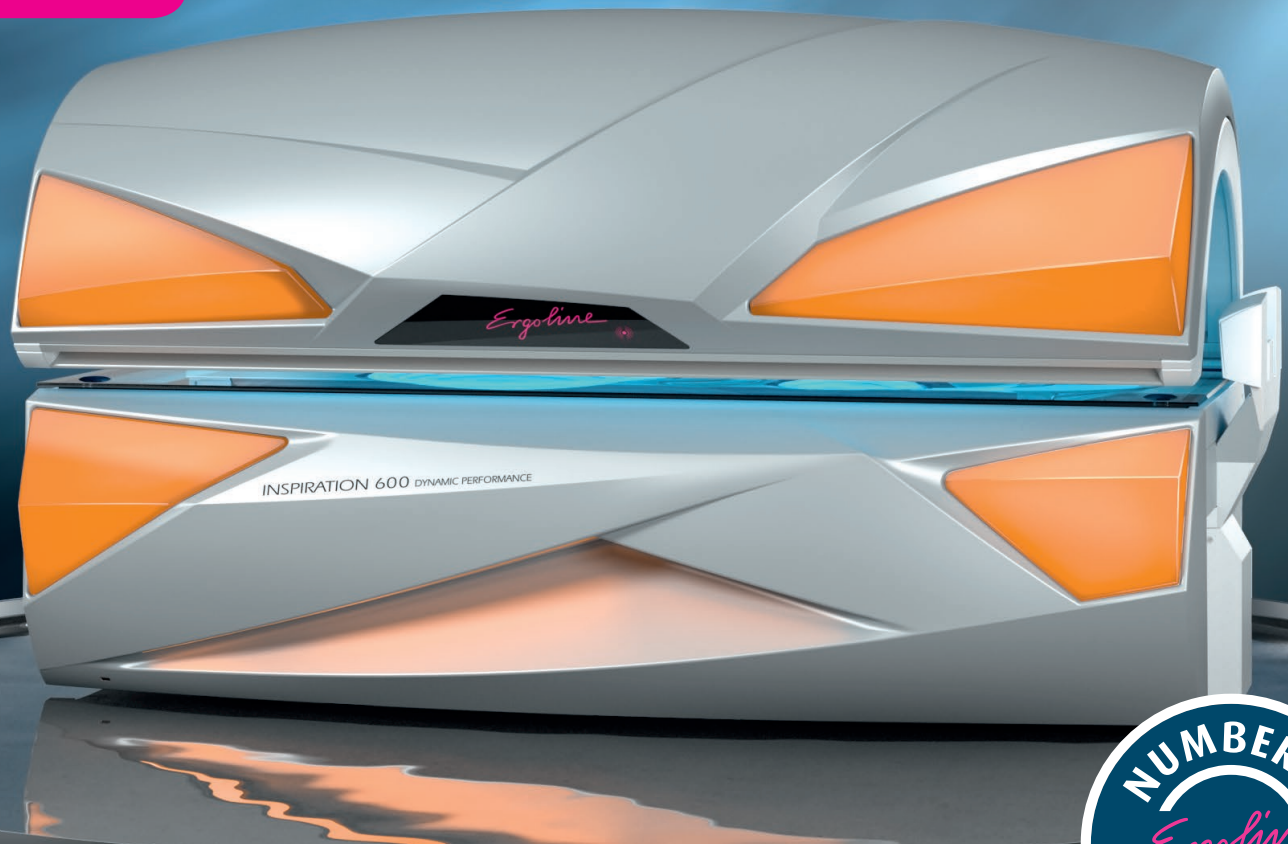

ERGOLINE INSPIRATION 600 DYNAMIC PERFORMANCE

GET **INSPIRED**

- **ELECTRONIC BALLASTS WITH DYNAMIC PERFORMANCE GUARANTEE OUTSTANDING AND EVEN TANNING RESULTS OVER THE ENTIRE LAMP LIFE**
- **LED LIGHT SHOW – A NEW HIGHLIGHT IN YOUR SALON**
- **NFC CONNECT – SIMPLE TRANSFER OF SETTINGS FOR SALON OWNERS AND TANNERS**
- **OPTIMIZED AIR CONDITION PLUS WITH COMFORT COOLING PLUS**



Ergoline

HIGHLIGHTS
INSPIRATION 600
DYNAMIC PERFORMANCE

STANDARD FEATURES

- DYNAMIC**



Dimmable electronic ballasts guarantee an even and increased UV-output over the entire lamp life up to 1,000 hours.
- PERFORMANCE**



Ultra Performance Plus technology with glass reflectors includes UV-B spaghetti lamps and special filters. It is the most advanced facial system on the market today.
- ULTRA**



High quality performance LED's guarantee impressive color brilliance with more than 200 colors and light effects. It features up to 80% energy savings and an operating life of more than 30,000 hours.
- LED LIGHT SHOW**



The new LED interior light emphasizes the features in the tanning tunnel. The brightly illuminated tanning tunnel appears particularly hygienic and invites your customers to tan.
- INTERIOR LIGHT**



Our ergonomically designed base acrylic Bodyform Plus will give you comfort second to none during your tanning session.
- BODYFORM PLUS**



Comfort Cooling PLUS wraps your body and face in a pleasant flow of cooling air. The ventilation for face and body automatically ensures the right climate.
- COMFORT COOLING+**



The new Air Condition PLUS cools the base acrylic and promises an overall refreshing feeling during the tanning session.
- AIR CONDITION +**



With NFC Connect various comfort settings can be saved on a customer card – all individual preferences are already set for the next visit. It's simple!
- NFC CONNECT**



Our 3D Sound System will bathe you in a sumptuous sea of sound as you tan. The system consists of two speakers, a subwoofer, and an SD card slot and MP3 connection.
- 3D SOUND**



With this function you can connect a MP3 player or a smartphone to enjoy your own music during the session. The Auto Play function will recognize the connection automatically.
- MP3 AUX**



Voice Guide walks you through every step in a pleasant, friendly voice as you control the tanning bed.
- VOICE GUIDE**



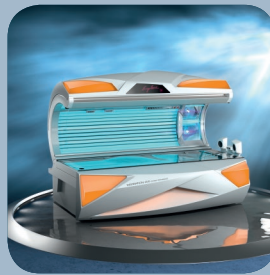

ERGOLINE INSPIRATION 600

DYNAMIC PERFORMANCE

Lamps	Watts max.	FT	Watts max.
42	200	4	400
UV-B	Watts		
3	8		

Maximum exposure schedule: 12 minutes

Standard features: Dynamic Performance, Ultra Performance PLUS, LED Light Show, Interior Light, Bodyform PLUS, Comfort Cooling PLUS, Air Condition PLUS, NFC Connect, 3D-Sound*

* 3D-Sound unit includes Voice Guide, MP3- & iPod-Connection, SD-Card-Slot Automatic Volume and Auto

TECHNICAL SPECS, DIMENSIONS AND DATA

- Optional exhaust plenum
- Total power consumption (in watts): 13,200
- Electrical requirements: 230V 3Ø or 230V 1Ø
- Circuit breaker recommended: 50A / 3-pole 3Ø or 80A / 2-pole 1Ø
- Number of wires required: 4 3Ø or 3 1Ø
- Dimensions closed (LxWxH in inches): 94 x 57 x 53
- Dimensions open (H in inches): 67
- Recommended room size (in feet): 9 x 8

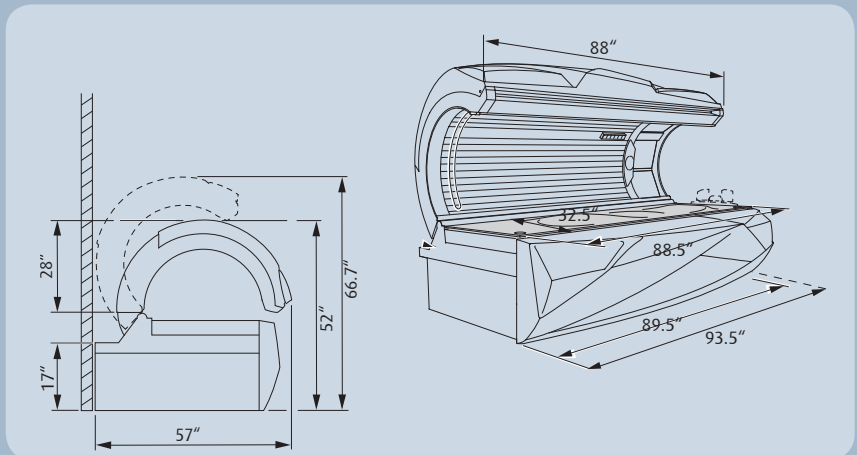

Contraindication: This product is contra indicated for use on persons under the age of 18 years.
 Contraindication: This product must not be used if skin lesions or open wounds are present.
 Warning: This product should not be used on individuals who have had skin cancer or have a family history of skin cancer.
 Warning: Persons repeatedly exposed to UV radiation should be regularly evaluated for skin cancer.
 Notice: Read the mandatory FDA warning label found on every tanning machine for important information on potential eye injury, skin cancer, skin aging and photosensitive reaction and proper use. Compliant protective eyewear must be worn when using any in-door tanning system or device.
 © 2014 JK Products & Services, Inc. reserves the right to change product designs, features, specifications, etc. without notice.

SUN ERGOLINE, A DIVISION OF JK PRODUCTS & SERVICES, INC.
 1 Walter Kratz Drive · Jonesboro, AR 72401
 ☎ 870.935.1130 @ ergoline@sunergoline.com 🌐 www.sunergoline.com
 📘 www.facebook.com/ErgolineWorld 🐦 @JKNorthAmerica

